

SUBMITTAL/TECHNICAL DATA SHEET



SPECIFICATIONS

01. Frame with flashing (Corners full welded)
 - 20VM - 14 gauge P.B. Galv. Steel
 - 50VM - 11 gauge aluminum
02. Pintle hinge
03. Gasket (all around cover)
04. Cover gauge
 - 20VM - 14 gauge P.B. Galv. Steel
 - 50VM - 11 gauge aluminum
05. Cover liner
 - 20VM - 22 gauge P.B. Galv. Steel
 - 50VM - 18 gauge aluminum
06. Spring lifting mechanism
07. 1° rigid fiberglass insulation
08. Slam latch
09. Inside and outside handles with padlock hasps
10. Arm guide bracket
11. 1" thick fiberglass cover insulation
12. Hold open arm w/red vinyl grip
13. Neoprene gasket
14. Lock strike & padlock hasp
15. Anchor tabs (QTY & location varies with size)
16. Guide arm (If req'd)

SHOP FINISH:

- STEEL: Red oxide primer
- ALUMINUM: Mill finish
- HARDWARE: Non-corrosive materials (Unless otherwise specified)

This product may be installed on either a flat or sloping roof. When installed on a slope, the hinge side must run parallel with the slope. If slope exceeds 30°, advise factory for modification

For a complete list of options visit www.AccessDoorsAndPanels.com

SKU: **EW 20VM**

SINGLE LEAF ROOF SCUTTLE

TYPE VM



DIMENSIONS AND APPEARANCE

>> CLICK TO VIEW ADDITIONAL DETAILS AND PRICING <<

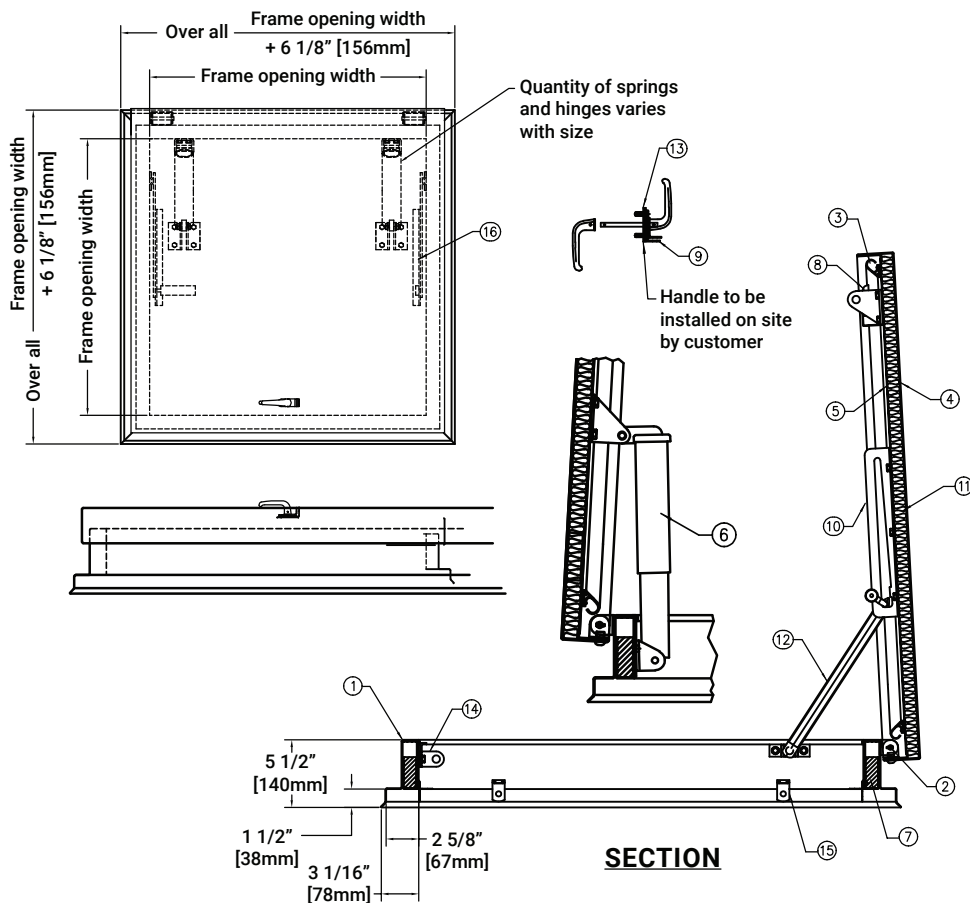

QTY	TYPE	QTY	TYPE	SIZE
				WIDTH X LENGTH
□	S-20VM	□	S-50VM	3'-0" X 2'-6" [914MM] X [762MM]
□	E-20VM	□	E-50VM	3'-0" X 3'-0" [914MM] X [914MM]
□	NB-20VM	□	NB-50VM	2'-6" X 4'-6" [762MM] X [1370MM]
□	L-20VM	□	L-50VM	2'-6" X 8'-0" [762MM] X [2440MM]
□	EW-20VM	□	EW-50VM	3'-3 3/8" X 3'-3 3/8" [1000MM] X [1000MM]

PROJECT DATA

Custom Sizes Available - Fast!

PROJECT NAME :	QTY	W	H	OPTIONS
ARCHITECT :				
DEALER :				
CONTRACTOR :				
LOCATION :	SPECIAL INSTRUCTIONS :			
DATE :				
TAGGING INSTRUCTIONS :	SUBMITTAL APPROVAL : (signature or stamp)			

Scan or Click



To view Pricing and Additional Product Info.

TELEPHONE:
1-888-457-1275
FAX:
1-888-626-2907



PO BOX 66738 #76520,
SAINT LOUIS, MO
63166-6738
USA



WEBSITE:
www.AccessDoorsAndPanels.com
E-MAIL:
info@AccessDoorsAndPanels.com